

Preparation of Monodisperse Food-Grade Oleuropein-Loaded W/O/W Emulsions Using Microchannel Emulsification and Evaluation of Their Storage Stability

Safa Souilem · Isao Kobayashi · Marcos A. Neves · Sami Sayadi · Sosaku Ichikawa · Mitsutoshi Nakajima

Received: 26 May 2013 / Accepted: 26 August 2013 / Published online: 11 September 2013
© Springer Science+Business Media New York 2013

Abstract W/O/W emulsion is an emerging system in developing new functional and low-calorie food products. The aim of this study is to produce food-grade monodisperse water-in-oil-in-water (W/O/W) emulsions loaded with a hydrophilic bioactive oleuropein. W/O/W emulsions were prepared via high-pressure homogenization and subsequent microchannel (MC) emulsification. The internal aqueous phase was a 5-mM sodium phosphate buffer containing D(+)-glucose (5 wt.%) and oleuropein (0.1–0.7 wt.%). The oil phase consisted of soybean oil and tetraglycerin monolaurate condensed ricinoleic acid esters (TGCR; 3–8 wt.%). The external aqueous phase was a 5-mM sodium phosphate buffer containing D(+)-glucose (5 wt.%) and decaglycerol monolaurate (1 wt.%). Oleuropein-loaded submicron W/O emulsions with average droplet diameters as small as 0.15 μm and monomodal droplet size distributions were prepared by high-pressure homogenization when applying high TGCR concentrations of 5–8 wt.% and low oleuropein concentrations of 0.1–0.3 wt.%. Monodisperse

oleuropein-loaded W/O/W emulsions with average W/O droplet diameters of around 27 μm and coefficients of variation of below 5 % were successfully prepared when using a silicon MC array plate with wide channels of 5- μm depth and 18- μm width. The monodisperse W/O/W emulsions prepared at high TGCR concentrations and low oleuropein concentrations were the most stable during 40 days of storage. The adsorption behavior of oleuropein at the internal aqueous–oil interface was relevant to W/O/W emulsions microstructure and stability. The results are believed to provide useful information for successfully preparing stable monodisperse W/O/W emulsions loaded with hydrophilic functional compounds. The surface activity of the loaded material seems to be a key parameter in optimizing the formulation of W/O/W food emulsion.

Keywords W/O/W emulsion · Oleuropein · Microchannel emulsification · Monodisperse emulsion · Emulsifier concentration · Surface activity

S. Souilem · M. A. Neves · S. Ichikawa · M. Nakajima (✉)
Graduate School of Life and Environmental Sciences,
University of Tsukuba, 1-1-1 Tennoudai, Tsukuba,
Ibaraki 305-8572, Japan
e-mail: nakajima.m.fu@u.tsukuba.ac.jp

S. Souilem · I. Kobayashi (✉) · M. A. Neves · M. Nakajima
Food Engineering, National Food Research Institute, NARO,
2-1-12 Kannondai, Tsukuba, Ibaraki 305-8642, Japan
e-mail: isaok@affrc.go.jp

S. Souilem · I. Kobayashi · M. A. Neves · M. Nakajima
Alliance for Research on North Africa (ARENA),
University of Tsukuba, 1-1-1 Tennoudai, Tsukuba,
Ibaraki 305-8572, Japan

S. Souilem · S. Sayadi
Center of Biotechnology of Sfax (CBS),
B.P. 1177, Sfax 3018, Tunisia

Introduction

A double emulsion, discovered by Seifriz in 1925, is a multi-compartment liquid dispersion where both water-in-oil (W/O) and oil-in-water (O/W) emulsions coexist. A water-in-oil-in-water (W/O/W) emulsion as a main type of double emulsion contains W/O droplets defined as oil droplets containing numerous small aqueous droplets. They have potential applications in foods, pharmaceuticals, and cosmetics (Mataumoto and Kang 1989; Okushima et al. 2004; van der Graaf et al. 2005). In food industry, W/O/W emulsions are promising as low-calorie foods targeted to combat growing obesity levels worldwide as a fraction of oil droplets was replaced by internal aqueous droplets. Several new food products have been formulated in the form of W/O/W emulsions, such as dressings, aromatic mayonnaises, and creams (Muschiolik 2007;

Kumar et al. 2012). Initial textural properties and mouth feel could be preserved as the oil phase ratio and specific area are the same as single emulsions (Muschiolik. 2007). W/O/W emulsions have also potential application in the area of functional food. In principle, both hydrophobic and hydrophilic molecules could be encapsulated in W/O/W emulsions. For instance, the internal aqueous phase serves as a reservoir to encapsulate sensitive hydrophilic bioactives, to mask the unpleasant taste of some bioactives, such as flavors and polyphenols (Hemar et al. 2010), and to enable controlled release of these bioactives during eating and digestion. As a result, the bioavailability of hydrophilic bioactives could be improved, which is a potential advantage of W/O/W emulsions for pharmaceutical applications (Benichou et al. 2004; Vladisavljević et al. 2006; Su et al. 2008; Mun et al. 2010). By contrast, the short-term life of W/O/W emulsions must be overcome to achieve its widespread food application. W/O/W emulsions are thermodynamically unstable systems with a strong tendency for W/O droplet coalescence, aqueous droplet shrinkage and swelling, and oil droplet flocculation and creaming (van der Graaf et al. 2005; McClements 2005). Their stability is influenced by many factors related to their composition and preparation method (Su et al. 2008). Two different emulsifiers solubilized in the oil and external aqueous phases stabilize two different interfaces in W/O/W emulsions. Diffusion of emulsifiers between these interfaces may cause destabilization of the emulsion structure (Richard et al. 1996; Dickinson 2011). Iancu et al. (2009) suggested that stability of W/O/W emulsions could be improved by using new polymeric hydrophilic/hydrophobic emulsifiers, increasing the viscosities of oil and internal aqueous phases, or by gelation of internal aqueous droplets.

W/O/W emulsions are usually prepared by the two-step process using conventional emulsification devices including high-speed blenders, rotor-stator homogenizers, ultrasonic homogenizers, and high-pressure homogenizers (McClements 2005). The second-step emulsification is critical, as high shear conditions could disrupt internal aqueous droplets, resulting in a low entrapment yield and wide W/O droplet size distributions. Membrane emulsification may be a method of choice for preparing W/O/W emulsions, which applies the low shear stress to the membrane surface during the formation of W/O droplets (Nakashima et al. 2000; van der Graaf et al. 2005; Vladisavljević and Williams 2007). Relatively monodisperse W/O/W emulsions with the minimum coefficient of variation (CV) of around 10 % have been obtained after permeating a W/O emulsion phase into an external aqueous phase (direct membrane emulsification) or a coarse W/O/W emulsion (premix membrane emulsification) through membrane pores (Scherze et al. 2005; Vladisavljević and Williams 2007).

Conversely, microchannel (MC) emulsification allows better control of the W/O droplet size distribution with the minimum CV below 5 % in W/O/W emulsions (Kawakatsu et al. 2001; Kobayashi et al. 2005). In MC emulsification,

W/O/W emulsions are prepared by simply forcing a W/O emulsion phase in an external aqueous phase through MC arrays fabricated on a silicon plate. The formation of W/O droplets by MC emulsion is a very mild process based on spontaneous transformation of the W/O emulsion phase that have passed through the channels (Sugiura et al. 2002). This droplet formation is especially useful as the second-step emulsification that can prevent the rupture of internal aqueous droplets. Sugiura et al. (2004) reported a high entrapment yield (91 %) of a hydrophilic fluorescent dye in the W/O/W emulsion obtained using MC emulsification.

Recently, there has been a great deal of attention to the application of olive leaf extract as a functional food component because of its immune boosting effect. Oleuropein is the major natural phenol of olive leaf extract; it is also present in argan oil and privet's leaves (Charrouf and Guillaume 2007). It is an inherently hydrophilic phenolic compound with an olive O/W partition coefficient of 6×10^{-4} (Rodis et al. 2002). Several researches have focused on the health benefits of oleuropein including its antioxidant (Saija et al. 1998; Benavente-García et al. 2000), antibacterial (Andreadou et al. 2006), antidiabetic (Jemai et al. 2009), and anticancer (Han et al. 2009) activities. However, oleuropein known as the bitter principle of olives makes its direct consumption unappreciable as food (Durlu-Ozkaya and Ozkaya, 2011). Moreover, oleuropein is sensitive to oxidation and enzymatic reactions during digestion. Markopoulos et al. (2009) reported that about half of orally administered oleuropein may be degraded during residence in the small intestine, indicating its poor bioavailability in the gastro-intestinal tract. Thus, there is a great need for designing a food-grade dispersion system that can protect oleuropein, improving its sensorial perceptions, and targeting its delivery in the human body. To our knowledge, the encapsulation of oleuropein in W/O/W emulsions has not yet been reported.

The primary purpose of this work was to prepare monodisperse food-grade oleuropein-loaded W/O/W emulsions using high-pressure homogenization and subsequent MC emulsification. We have first optimized hydrophobic emulsifier and oleuropein concentrations for the preparation of W/O emulsions. Next, we investigated the formation characteristics of W/O/W emulsions using MC with different channels width under different hydrophobic emulsifier and oleuropein concentrations. Finally, we evaluated the physical stability of W/O/W emulsions according to the different formulation parameters.

Material and Methods

Chemicals

Oleuropein with a purity of >80 % was purchased from Extrasynthèse (France). Sodium phosphate reagents ((NaH₂PO₄

and 2H₂O) and (Na₂HPO₄ and 12H₂O)), refined soybean oil and D(+)-glucose were purchased from Wako Pure Chemical Industries Ltd. (Japan). Tetraglycerin monolaurate condensed ricinoleic acid esters (TGCR; CR-310) with a hydrophilic–lipophilic balance (HLB) of <1 were kindly provided by Sakamoto Yakuhin Kogyo Co. Ltd. (Japan). Decaglycerol monolaurate (DGM; Sunsoft A-12E) with a HLB of 14.8 was kindly provided by Taiyo Kagaku Co. Ltd. (Japan). These two emulsifiers are of food-grade. Calcein was purchased from Sigma-Aldrich Co. LLC (USA). Cobalt chloride (CoCl₂) was purchased from Kanto Chemical Co. Inc. (Japan). All the chemicals were used for experiments without further purification.

Preparation of Oleuropein-Loaded W/O/W Emulsions

As schematically represented in Fig. 1, each oleuropein-loaded W/O/W emulsion was prepared by a two-step emulsification process that consists of the first-step emulsification to obtain a W/O primary emulsion and the second-step emulsification to obtain a W/O/W emulsion. Sodium phosphate buffer (5 mM, pH 7.1) was used as the medium of internal and external aqueous phases.

First-step Emulsification by High-pressure Homogenization

To prepare an oleuropein-loaded W/O emulsion, 40 g of an oil phase containing 3, 5, and 8 wt.% of TGCR was first mixed with 10 g of an internal aqueous phase containing (0.1, 0.3, 0.5, and 0.7 wt.%) oleuropein and glucose (5 wt.%). The resulting two-phase mixture was emulsified using a rotor-stator homogenizer (Polytron PT 3100, Kinematica AG, Switzerland) at 5,000 rpm for 5 min. During homogenization, the sample vessel was surrounded with crushed ice to avoid its temperature

elevation. The resulting coarse W/O emulsion was immediately introduced to a high-pressure homogenizer (Nanomizer NV200, Yoshida Kikai, Co. Ltd., Japan) to prepare a feed W/O emulsion. High-pressure homogenization was conducted in a single pass at 140 MPa (flow rate, 5.7 L/h) and 15 °C. Such a low temperature was applied to avoid oleuropein degradation due to heat produced inside the homogenizer.

Second-Step Emulsification by MC Emulsification

Oleuropein-loaded W/O/W emulsions were prepared using MC emulsification. The to-be-dispersed phase was a freshly prepared W/O emulsion, and the external aqueous phase was a 5 mM phosphate buffer containing 1 wt.% DGM necessary for stabilizing the W/O droplets formed. Isoosmotic conditions were maintained between the internal and external aqueous phases. Their osmotic pressures were adjusted to 0.7 MPa, as calculated by the Morse equation modified from van't Hoff equation:

$$\Pi = iMRT \quad (1)$$

where Π is the osmotic pressure, i is the van't Hoff factor with a value of 1, M is the molecular concentration of solute, R is the gas constant (8.31 kPa m⁻³ K⁻¹), and T is the thermodynamic temperature (298 K).

Figure 2a schematically depicts the MC emulsification setup that consists of an emulsification module equipped with an MC array plate, a 10-mL reservoir containing the W/O emulsion, a syringe pump (Model 11, Harvard Apparatus Inc. USA) for supplying the external aqueous phase, and a microscope video system. Figure 2b schematically depicts the silicon 15×15-mm² MC array plate (model CMS6) used in this study (Chuah et al. 2009). The micrograph in Fig. 2b shows that each MC array consists of parallel channels and terraces outside their outlets and that there are deeply etched wells over the terrace ends. Two MC array plates with different channel widths were used in this study (Table 1).

During module assembly, a glass plate was firmly attached to the MC array to form closed channels between them. The flow directions of the two phases on the MC array plate and through the channels and the droplet formation through MC arrays are schematically shown in Fig. 2a. The to-be-dispersed W/O emulsion was supplied into the module by lifting the reservoir. The hydrostatic pressure (ΔP) applied to the W/O emulsion, which ranged from 1.2 to 2.5 kPa, was calculated using the following equation:

$$\Delta P = \rho g \Delta h \quad (2)$$

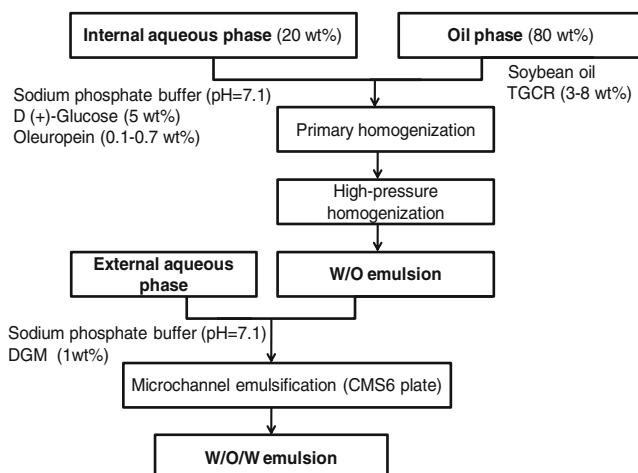
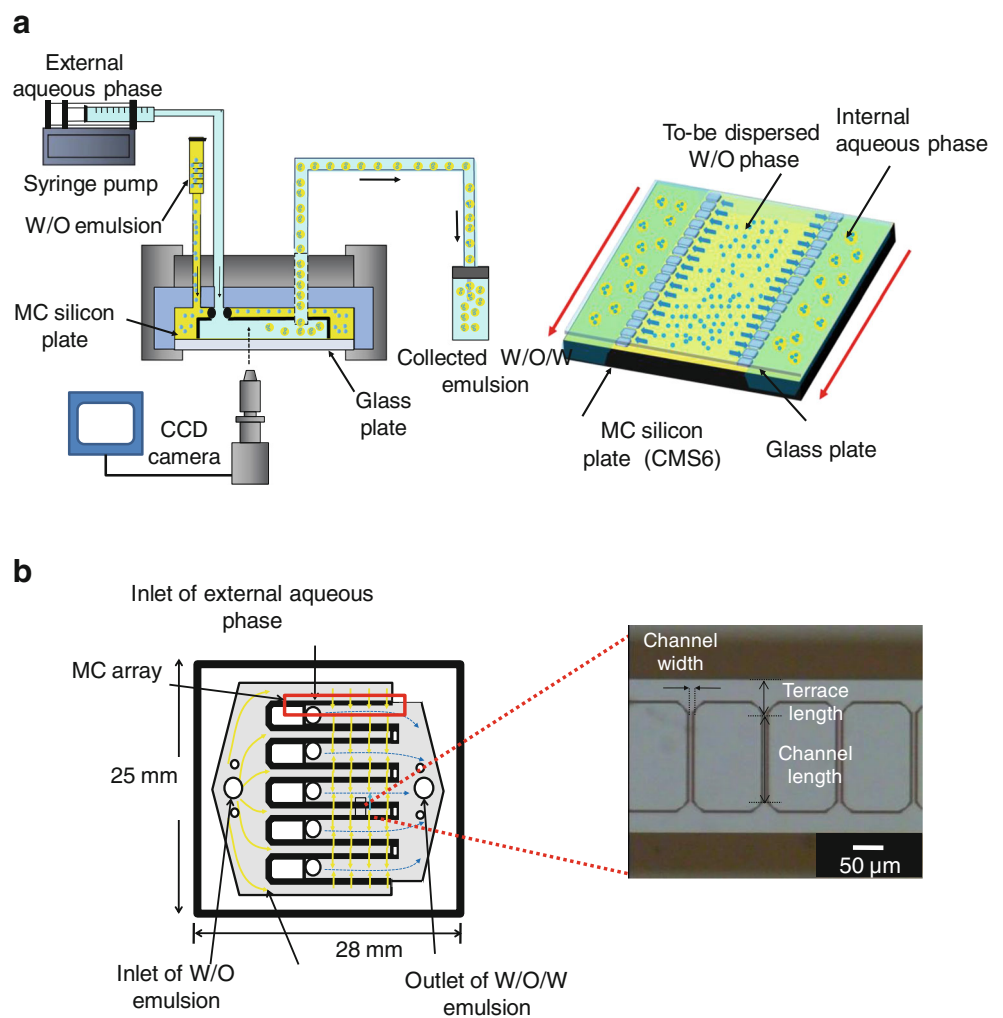

Fig. 1 Schematic diagram of preparing oleuropein-loaded W/O/W emulsions by high-pressure homogenization and subsequent MC emulsification

Fig. 2 **a** Simplified schematic drawing of MC emulsification setup for a preparing W/O/W emulsion. **b** Schematic diagram of a silicon grooved MC array plate (model CMS6) and optical micrograph of part of an MC array



where ρ is the density of the W/O emulsion, g is the acceleration due to gravity, and Δh is the difference in the hydraulic heads between the MC array plate and the reservoir containing the W/O emulsion. The flow rate of the external aqueous phase was $0\text{--}2\text{ mL h}^{-1}$. The formation of W/O droplets through the channels was monitored in real time using the microscope video system. All MC emulsification experiments were performed at a room temperature (nearly $25\text{ }^\circ\text{C}$).

Microscopic Observation

Microscopic analyses of the prepared W/O/W emulsions were conducted to gain information about their microstructure and droplet size distribution. An inverted optical microscope

(Leica DM IRM; Leica Microsystems, Germany) was used in these analyses. Prior to optical microscopic observation, emulsion samples were shaken gently. A drop of the emulsion was placed on the well of a microscope slide and then covered with a cover slip. The photomicrography images of the emulsions were captured using a microscope digital camera (DFC300 FX) and digital image processing software (Leica application Suite).

Droplet Size Determination

The average aqueous droplet diameter ($d_{av, W/O}$) and droplet size distribution of the W/O emulsions stabilized by TGCR were determined at $25\text{ }^\circ\text{C}$ using a dynamic light scattering

Table 1 Geometric characteristics of MC array plates used in this study

MC array plate	Channel depth (μm)	Channel length (μm)	Channel width (μm)	Terrace length (μm)	Terrace depth (μm)	Number of channels
CMS6-1	5	140	8	40	5	1,040
CMS6-2	5	140	18	60	5	540

particle size analyzer that has a measuring range of 0.6 nm to 6 μm (Zetasizer Nano-ZS, Malvern Instruments, UK). Measurements were repeated in triplicate and average values were used. Prior to analysis, W/O emulsion samples were diluted with a mixture of chloroform and hexane (50 wt.% of each) that has a refractive index of 1.40 at 25 °C, to avoid multiple scattering effects during the measurement. Polydispersity index (PDI) is a dimensionless number that measures the width of the size distribution. Its maximum value is arbitrarily limited to 1.0.

The average diameter of W/O droplets, defined as oil droplets containing smaller internal aqueous droplets ($d_{\text{av, W/O/W}}$) and their size distribution in the W/O/W emulsions were determined using images of 100 W/O droplets obtained with the microscope video system (Fig. 2a). *WinRoof* software (Mitani Co. Ltd. Japan) was used to measure the diameter of W/O droplets in the captured images. Their CV was calculated based on the following equation:

$$CV = (\sigma/d_{\text{av, W/O/W}}) \times 100 \quad (3)$$

where σ is the standard deviation of the droplet diameter.

ζ -potential Determination

The ζ -potential of the oil droplets containing internal aqueous droplets was determined at 25 °C using a ζ -potential analyzer that has a measuring range of 20 nm to 100 μm (Melles Griot 05-LHP-121, USA). W/O/W emulsion samples were first diluted by using the external aqueous phase used for MC emulsification. Each of the diluted samples was filled in a transparent glass cell. During measurement, the electrophoretic mobility of the droplets was determined by measuring the direction and velocity of the droplet movement under electric field (20 mV). The software that adopts the Smoluchowsky mathematical model then converted these electrophoretic mobility data to ζ -potential values.

Determination of Entrapment Yield in W/O/W Emulsions

Calcein, a model hydrophilic fluorescent compound, was added to the internal aqueous phase to comprehend the efficacy of W/O/W emulsions used for encapsulating oleuropein. The entrapment yield of oleuropein added with calcein was determined fluorometrically by a slight modification of the method reported by Sugiura et al. (2004). When preparing W/O/W emulsions encapsulating calcein, a sodium phosphate-buffered solution containing calcein (0.4 mM) and oleuropein (0.1 wt.%) was used as the internal aqueous phase. The calcein content in W/O/W emulsions was determined using a fluorescence spectrophotometer (FP-777, JASCO Co. Japan). The excitation and emission wavelengths

were 490 and 520 nm, respectively. The calcein entrapment yield was calculated as follows:

$$\text{Entrapment yield}(\%) = ((F_{\text{in}} - F_{\text{q}}) / (F_{\text{tot}} - F_{\text{q}})) \times 100 \quad (4)$$

where F_{tot} is the fluorescence intensity of the entire W/O/W emulsion, F_{in} is the fluorescence intensity in the W/O droplets after adding cobalt (II) to the external aqueous phase, and F_{q} is the fluorescence intensity of the external aqueous phase in the absence of calcein.

Determination of the Fluid Properties

The densities of liquid phases that are required for determining interfacial tension were measured using a density meter (DA-130N, Kyoto Electronics Manufacturing Co. Ltd., Japan). The interfacial tension between two immiscible phases was determined at 25 °C using a full automatic interfacial tensiometer (PD-W, Kyowa Interface Science Co. Ltd., Japan) that adopts a pendant drop method. A drop of soybean oil pure, or containing small aqueous droplets was formed in an external aqueous phase. Interfacial tension data were averaged from at least nine determinations. The dynamic viscosities of liquid phases and W/O emulsions were determined using glass capillary viscometers (SO-200 and SO-350; Shibata Scientific Technology Ltd., Japan). This dynamic viscosity is defined as the ratio of the viscosity measured to the density determined. All the measurements were performed at 25 °C.

Statistical Analysis

All samples were analyzed in triplicate. Data were expressed as the mean \pm standard deviation. Statistical analyses were based on differences between means using the Student's *t* test. Statistical significance was judged at an *p* level of 0.05.

Results and Discussion

Preparation Characteristics of Oleuropein-Loaded W/O Emulsions

Effect of TGCR Concentration

Oleuropein-loaded W/O emulsions were prepared at different TGCR concentrations (3–8 wt.%) and a fixed oleuropein concentration (0.1 wt.%) in the internal aqueous phase. The coarse W/O emulsions prepared by Polytron homogenization had a $d_{\text{av, W/O}}$ of around $2 \pm 0.02 \mu\text{m}$ with a PDI of 0.41 ± 0.02 . The droplet size distributions of the W/O emulsions obtained by high-pressure homogenization are shown in Fig. 3a. The $d_{\text{av, W/O}}$ and PDI of the resulting W/O emulsions were $0.31 \pm$

Fig. 3 a, b Effect of TGCR concentration on the droplet size distribution of the W/O emulsions and their average droplet diameter ($d_{av, W/O}$) and PDI. The oleuropein concentration in the internal aqueous phase was 0.1 wt.%. **c, d** Effect of oleuropein concentration on the droplet size distribution of the W/O emulsions prepared and their $d_{av, W/O}$ and PDI. The TGCR concentration in the oil phase was 5 wt.%

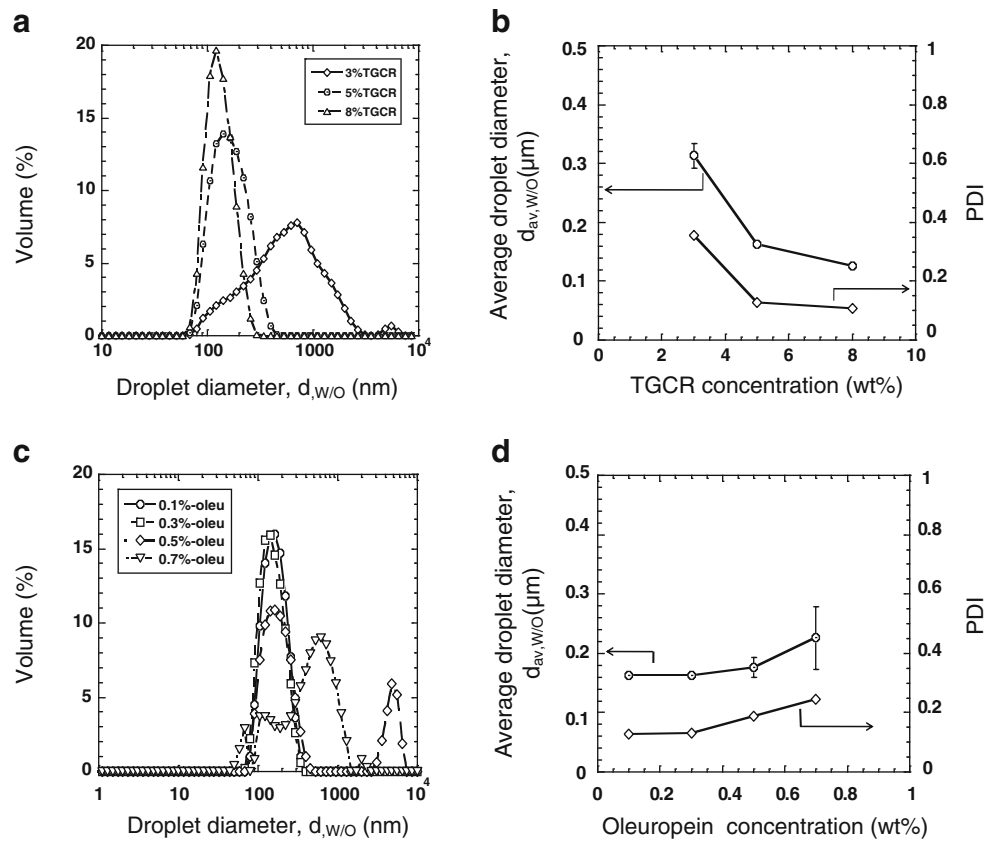

0.02 μm and 0.36 ± 0.02 for 3 wt.% TGCR, 0.16 ± 0.02 μm and 0.13 ± 0.01 for 5 wt.% TGCR, and 0.13 ± 0.02 μm and 0.11 ± 0.02 for 8 wt.% TGCR (Fig. 3b). The $d_{av, W/O}$ for 3 wt.% TGCR was pronouncedly higher than that for 5 and 8 wt.% TGCR ($p < 0.05$). Particularly, submicron W/O emulsions stabilized by 5 and 8 wt.% of TGCR showed monomodal size distributions with small PDI values. A high TGCR concentration increased the surface area of emulsions and decreased their polydispersity. The interfacial tension between the internal aqueous phase and the oil phase (Table 2) gradually decreased with increasing the TGCR concentration, indicating that the trend in the $d_{av, W/O}$ values is reasonable. A broader droplet size distribution for 3 wt.% TGCR may be caused by droplet coalescence due to insufficient adsorption of TGCR molecules at the newly created interface during

high-pressure homogenization. Emulsion samples had a whitish color, indicating unpronounced oleuropein degradation during emulsification. Oleuropein degradation in an aqueous solution is usually expressed as a brownish color, compared with its initially yellowish color.

Effect of Oleuropein Concentration

Figure 3c shows the effect of oleuropein concentration on the droplet size distribution of W/O emulsions stabilized by 5 wt.% TGCR. Submicron W/O emulsions with a $d_{av, W/O}$ of about $0.17 \mu\text{m}$ and a monomodal droplet size distribution were successfully obtained at low oleuropein concentrations (0.1 and 0.3 wt.%) in the internal aqueous phase. Increasing the oleuropein concentration caused the preparation of W/O

Table 2 Viscosity and interfacial tension data for the W/O/W systems used in this study

TGCR concentration ^a (wt.%)	Oleuropein concentration ^a (wt.%)	Internal aqueous phase	Viscosity (mPa·s)		Interfacial tension (mN m ⁻¹)	
			Oil phase	W/O emulsion	Oil and W1	W1/O and W2
3	0.1	0.95±0.02	53.2±4.0	88.6±1.4	5.4±0.1	3.1±0.1
5	0.1	0.95±0.02	63.6±2.7	136.9±1.3	4.9±0.1	3.4±0.1
5	0.3	0.95±0.02	63.6±2.7	113.8±2.7	4.5±0.1	3.3±0.1
5	0.5	0.95±0.02	63.6±2.6	104.7±3.0	3.6±0.1	2.8±0.1
5	0.7	0.95±0.02	63.6±2.6	103.8±3.6	3.3±0.1	2.6±0.1
8	0.1	0.95±0.02	83.8±2.0	146.8±2.1	4.5±0.1	2.7±0.1

W1 internal aqueous phase, W2 external aqueous phase

^a Oleuropein concentration in the internal aqueous phase

^b TGCR concentration in the oil phase

emulsions with a multimodal size distribution and peak(s) to shift toward greater size. The second larger peak in the droplet size distribution for 0.7 wt.% oleuropein disappeared (Fig. 3c), which would be due to the upper limit of measurable size (6 μm) of the particle size analyzer used in this study. These results were interpreted by using the interfacial tension between the oil phase containing 5 wt.% TGCR and the internal aqueous phase containing different oleuropein concentrations (Table 2). In the absence of oleuropein, the interfacial tension measured was 6.5 mN m^{-1} . Oleuropein addition to the aqueous solution pronouncedly reduced the interfacial tension, even in the presence of TGCR ($p < 0.05$). This behavior suggests the surface activity of oleuropein. The partial presence of oleuropein at the O/W interface may noticeably change the composition of the interfacial layer. The resistance of the

interfacial film to expansion could reduce at higher oleuropein concentrations, as droplet coverage by TGCR molecules would become relatively insufficient. Villa et al. (2003) reported that addition of strong emulsifiers (e.g., Tween 80 or sodium dodecyl sulfate) to the internal aqueous phase induced drastically enhanced coalescence of internal aqueous droplets in W/O/W systems, as these hydrophilic emulsifiers dominantly adsorb at the interface in the presence of a hydrophobic emulsifier. We assume that TGCR molecules dominantly adsorbed at the surface of fine aqueous droplets at low oleuropein concentrations (0.1 and 0.3 wt.%) because of unchanged $d_{\text{av, W/O}}$ value (Fig. 3d). By contrast, at higher oleuropein concentrations, more pronounced oleuropein adsorption may have affected the interfacial properties, resulting in lower interfacial tension and greater $d_{\text{av, W/O}}$ and PDI values.

Fig. 4 **a, b** Effect of channel width on the preparation of W/O/W emulsions using CMS6-1 and CMS6-2 plates. The oleuropein concentration in the internal aqueous phase was 0.1 wt.%. Optical micrographs at the bottom of **(a)** and **(b)** are the W/O/W emulsions in the module. **c, d** Variations in the preparation of the W/O/W emulsions at different oleuropein concentrations in the internal aqueous phase as a function of time. The TGCR concentration in the oil phase was 5 wt.% in **(a)** to **(d)**

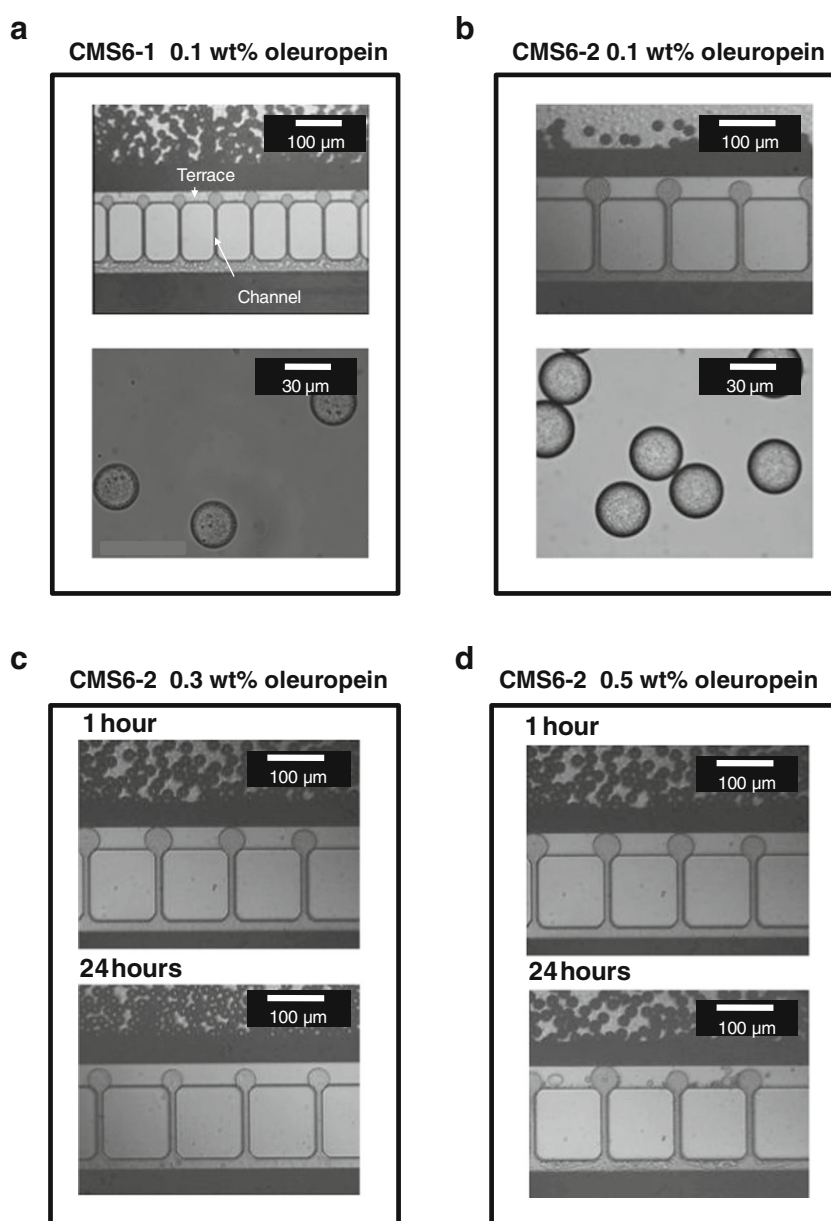

Preparation Characteristics of Oleuropein-Loaded W/O/W Emulsions Using MC Emulsification

Effect of the Channel Width

The second-step emulsification was performed using two MC array plates with the same channel depth of 5 μm and different channel widths of 8 and 18 μm (Table 1). The continuous phase used was a 5-mM sodium phosphate-buffered solution containing 1 wt.% DGM, and the to-be-dispersed phase was a submicron W/O emulsion stabilized by TGCR (5 wt.% in the

oil phase) and consisting of internal aqueous droplets containing 0.1 wt.% oleuropein. The use of CMS6-1 plate consisting of narrow channels led to the formation of uniformly sized W/O droplets with a $d_{\text{av, W/O/W}}$ of 27.1 μm and a CV of 4.2 % were formed using CMS6-1 plate (Fig. 4a). However, the micrograph at the top of Fig. 4a demonstrated the presence of some coalesced aqueous droplets in the terrace, especially near the channel inlet. When pressurizing the to-be-dispersed W/O emulsion, the internal aqueous droplets caused aggregation in front of the narrow channel inlets because of the low viscosity ratio of the internal aqueous phase to the oil phase

Fig. 5 **a** Effect of TGCR concentration on the W/O droplet size distribution of the W/O/W emulsions. **b** Optical micrographs of the prepared W/O/W emulsions. The oleuropein concentration in the internal aqueous phase was 0.1 wt.%

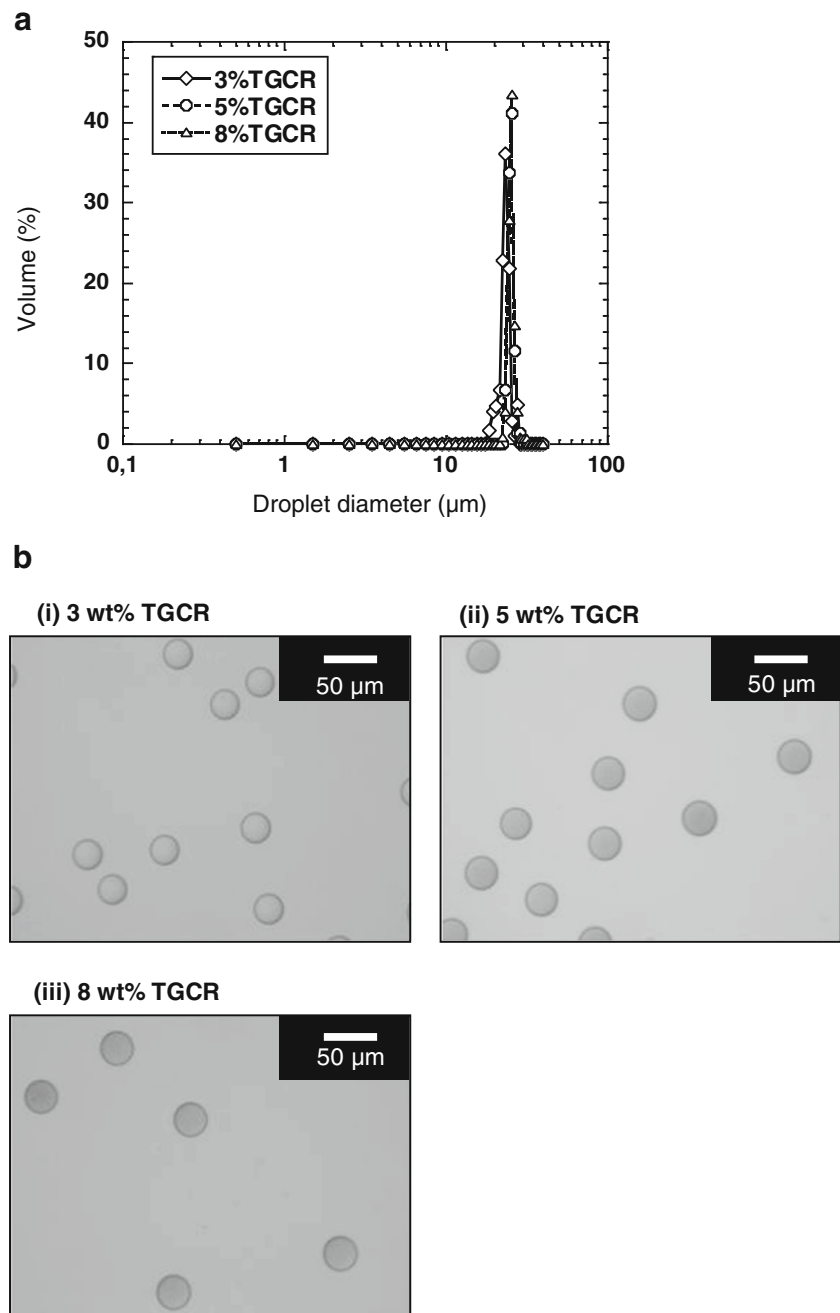

(Table 2) as well as the laminar flow from the inlet-side terrace into the channels. Some of the aggregated droplets that were stabilized by TGCR molecules may have interacted with the hydrophilic and negatively charged terrace surface, resulting in wetting and/or coalescence of the internal aqueous droplets in the inlet-side terrace.

When the CMS6-2 plate consisting of wide channels was used for MC emulsification, uniformly sized W/O droplets with a $d_{av, W/O/W}$ of 27.1 μm and a CV of 4.9 % were stably formed from the channels (Fig. 4b). In this case, the oil phase and internal aqueous droplets of the to-be-dispersed W/O emulsion flowed smoothly through the wide channels, followed by the formation of the interface that expands symmetrically in the terrace. There was no visible aggregation of the internal aqueous droplets during 24 h of MC emulsification. W/O droplets were also successfully formed in the absence of a cross-flow of the external aqueous phase, indicating spontaneous-transformation-based droplet formation driven by interfacial tension (Sugiura et al. 2001). Sugiura et al. (2002) demonstrated that the use of narrow channels provides the stable formation of oil droplets at a higher frequency due to a higher critical velocity of the dispersed oil phase in the channels. By contrast, our results demonstrated that an MC array plate consisting of wide channels is preferable for successfully preparing monodisperse W/O/W emulsions containing uniformly sized W/O droplets, since we could prevent wetting and/or coalescence of the internal aqueous droplets in front of the channel inlets. The CMS6-2 plate was thus used in the later sections.

Effect of TGCR Concentration in the Oil Phase

The effect of TGCR concentration in the oil phase on the preparation of W/O/W emulsions by MC emulsification was investigated using the internal aqueous phase with an oleuropein concentration of 0.1 wt.% and the external aqueous phase with a DGM concentration of 1 wt.%. Optical microscopy demonstrated the successful formation of uniformly sized W/O droplets via MC arrays as well as no visible leakage of fine aqueous droplets from the oil phase, regardless of the TGCR concentrations applied (e.g., top of Fig. 4b). The interfacial tension between the W/O emulsion phase and the external aqueous phase was hardly affected by the TGCR concentration ($p < 0.05$) (Table 2), implying that DGM dominantly adsorbed at the external oil-aqueous interface. Figure 5a shows the size distributions of the fresh W/O droplets, each containing fine aqueous droplets, at different TGCR concentrations (3–8 wt.%). W/O droplets with highly narrow size distribution and a CV below 5 % were obtained, and their size monodispersity was confirmed by their optical micrographs (Fig. 5b). Their $d_{av, W/O/W}$ was $24.6 \pm 0.35 \mu\text{m}$ for 3 wt.% TGCR, $27.1 \pm 0.27 \mu\text{m}$ for 5 wt.% TGCR, and $27.2 \pm 0.19 \mu\text{m}$ for 8 wt.% TGCR.

Figure 6a shows the ζ -potential of the surface of the W/O droplets formed at different TGCR concentrations. The ζ -

potential with values of about -30 mV was unaffected by the TGCR concentration ($p > 0.05$). Several researchers have reported that dispersions should have an absolute minimum ζ -potential of around -30 mV to prevent their destabilization in terms of coalescence and aggregation (Chu et al. 2007; Wang et al. 2012). The monodisperse W/O/W emulsions prepared here are assumed to be stable because of electrostatic repulsion.

Figure 6b shows the entrapment yield of calcein in the W/O/W emulsions prepared at different TGCR concentrations. The internal aqueous phase contained oleuropein (0.1 wt.%) and calcein (40 mM). It should be noted that hydrophilic calcein with a molecular weight similar to

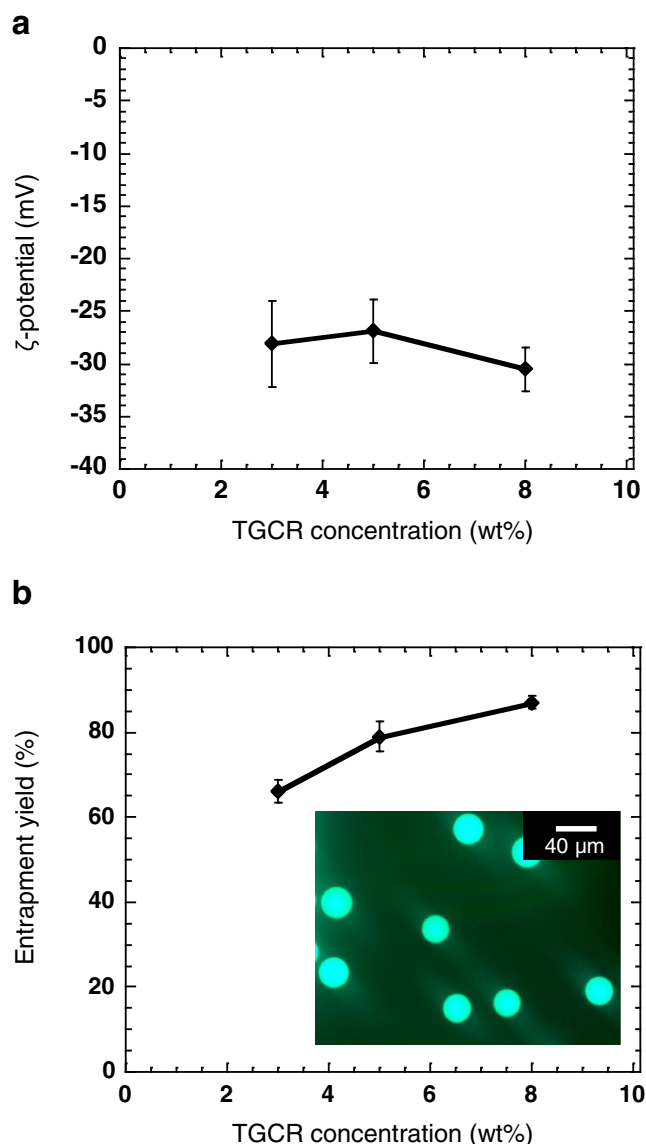

Fig. 6 Effect of TGCR concentration on the ζ -potential of the W/O droplets dispersed in the external aqueous phase (a) and the entrapment yield of calcein in the prepared W/O/W emulsions (b). The oleuropein concentration in the internal aqueous phase was 0.1 wt.%

oleuropein is useful to estimate the entrapment efficiencies of oleuropein in the W/O/W emulsions. The entrapment yield of calcein gradually increased from 67.1 to 86.9 % as the TGCR concentration increased ($p < 0.05$). The fluorescent micrograph in Fig. 6b confirmed the high entrapment yield of calcein when using 8 wt.% TGCR, because almost no fluorescence was detected in the external aqueous phase of the prepared W/O/W emulsion. The entrapment yield data shown in Fig. 6b suggest that a large portion of the oleuropein initially solubilized in the internal aqueous phase was encapsulated in the W/O/W emulsions when increasing TGCR concentration in the oil phase.

Effect of Oleuropein Concentration in the Internal Aqueous Phase

Here we prepared W/O/W emulsions using the CMS6-2 plate at a fixed TGCR concentration (5 wt.%) in the oil phase and at different oleuropein concentrations in the internal aqueous phase. The W/O emulsion phase that passed through the channels were spontaneously transformed into uniformly sized W/O droplets at all the oleuropein concentrations applied. The resultant W/O/W emulsions had $d_{av, W/O/W}$ of about 27 μm and highly narrow size distributions of W/O droplets with their CV below 5 % (Fig. 7a). The resultant $d_{av, W/O/W}$

Fig. 7 **a** Effect of oleuropein concentration on the W/O droplet size distribution of the W/O/W emulsions. **b** Optical micrographs of the prepared W/O/W emulsions. The TGCR concentration in the oil phase was 5 wt.%

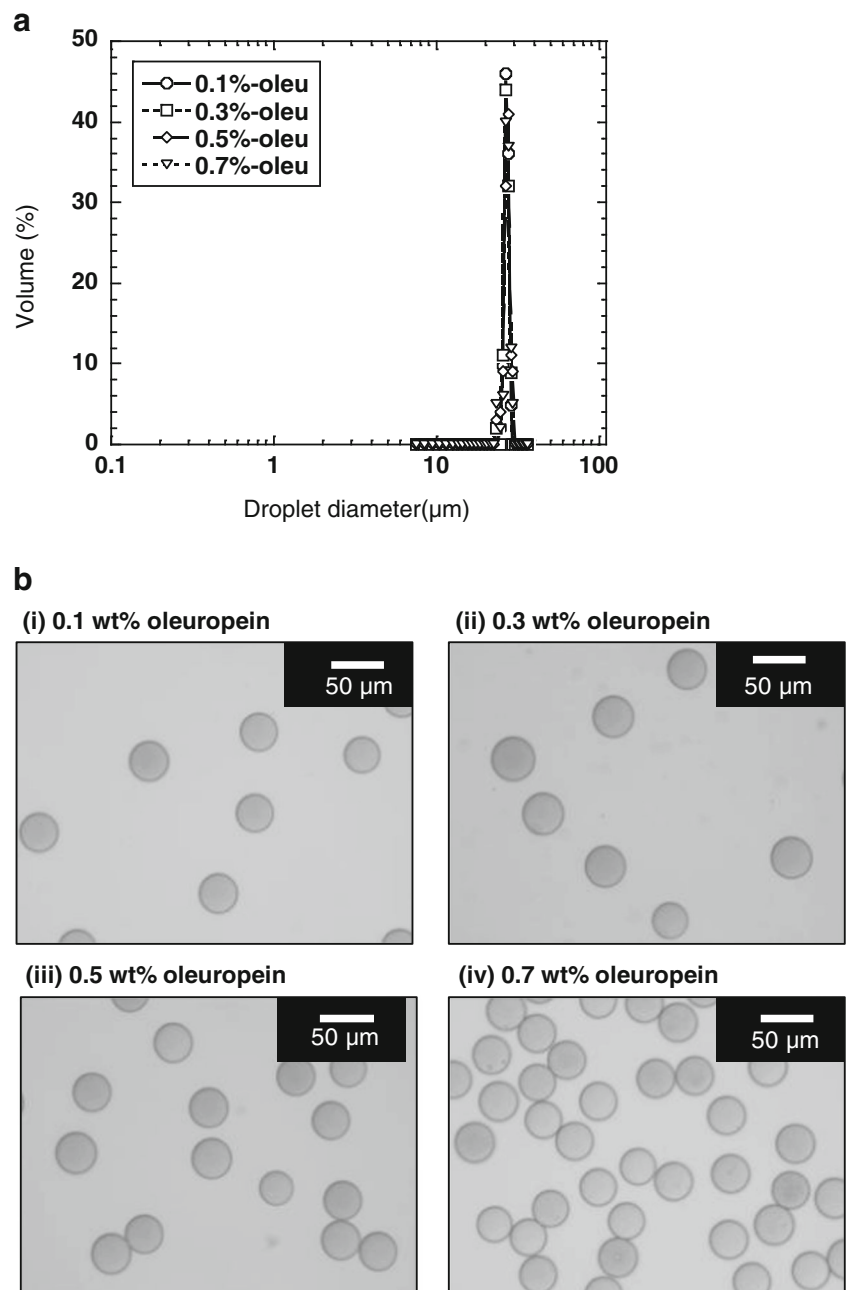

values were unaffected by the slight decrease of W/O viscosity caused by increasing oleuropein concentration. The generation behavior of W/O droplets via MC arrays fabricated on the CMS6-2 plate was dependent on the oleuropein concentration. At the oleuropein concentrations of 0.1 and 0.3 wt.%, aqueous droplets appeared to smoothly pass through the channels during 24 h of continuous MC emulsification (Fig. 4b, c), which is reasonable due to that the $d_{av, W/O}$ values were considerably smaller than the channel size. By contrast, at the oleuropein concentrations of 0.5 and 0.7 wt.%, larger aqueous droplets accumulated mainly in front of the channel inlets after the continuous MC emulsification (Fig. 4d),

resulting in a lower fraction of the internal aqueous droplets that have passed through the channels. Microscopic observation of resultant droplets also confirmed the presence of some coalesced internal aqueous droplets in fresh W/O/W emulsions at the high oleuropein concentration of 0.7 wt.% (Fig. 7b).

Storage Stability of Oleuropein-Loaded W/O/W Emulsions

The oleuropein-loaded W/O/W emulsions were stored at 25 °C for 40 days to investigate their stability in terms of the

Fig. 8 **a** Effect of TGCR concentration on the variation in the average W/O droplet diameter ($d_{av, W/O/W}$) and CV of the prepared W/O/W emulsions during 40 days of storage. The oleuropein concentration in the internal aqueous phase was 0.1 wt.%. **b** Optical micrographs of the W/O/W emulsions after 40 days of storage

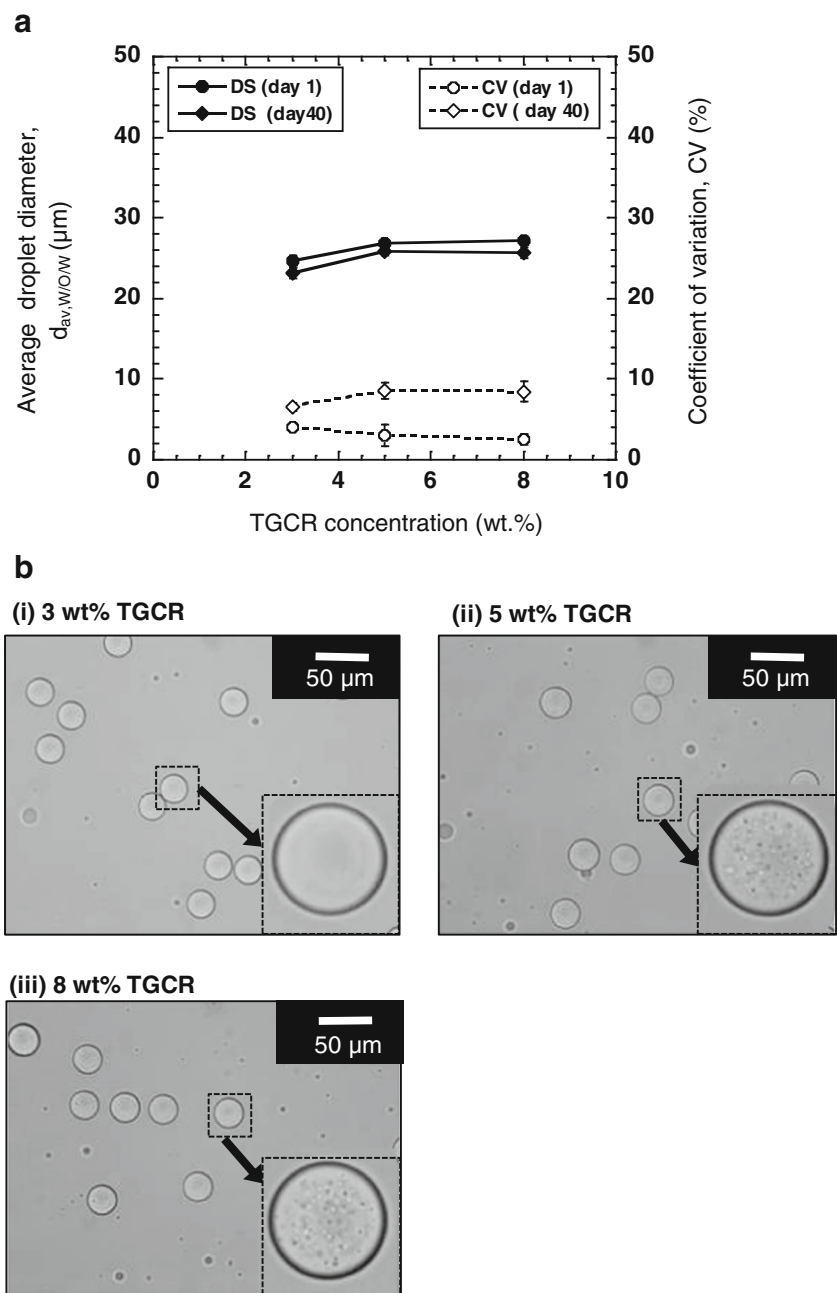

variation of their $d_{av, W/O/W}$, CV, microstructure, and appearance during storage.

Effect of TGCR Concentration in the Oil Phase

Figure 8a shows the variation in the $d_{av, W/O/W}$ of the oleuropein-loaded W/O/W emulsions during storage at the different TGCR concentrations tested. The oleuropein concentration in the internal aqueous phase was 0.1 wt.%. The relatively large W/O droplets obtained by MC emulsification moved upwards, forming a thin creaming layer on the surface of the W/O/W emulsion samples. It should be mentioned that these W/O droplets were easily redispersed with gentle shaking. The $d_{av, W/O/W}$ of all the resultant W/O

droplets slightly decreased by 2.6 to 4.9 % during storage, suggesting high stability against coalescence of the adjacent W/O droplets. The CV of the resultant W/O droplets, which slowly increased during storage, remained relatively low values of 6.6 to 8.9 % after 40 days. The W/O droplets stabilized by TGCR (5 and 8 wt.% in the oil phase) contained numerous fine internal aqueous droplets during the entire storage period (Fig. 8b(ii, iii)). On the contrary, those stabilized by 3 wt.% TGCR looked brighter and clearer after 40 days (Fig. 8b(i)), which may be attributed to a progressive release of the internal aqueous droplets into the external aqueous phase. This result also indicates a lower entrapment yield of oleuropein in the aqueous droplets. We assume that the low TGCR concentration resulted in

Fig. 9 a Effect of oleuropein concentration on the variation in the average W/O droplet diameter ($d_{av, W/O/W}$) and CV of the prepared W/O/W emulsions during 40 days of storage. The TGCR concentration in the oil phase was 5 wt.%. **b** Optical micrographs of the W/O/W emulsions after 40 days of storage

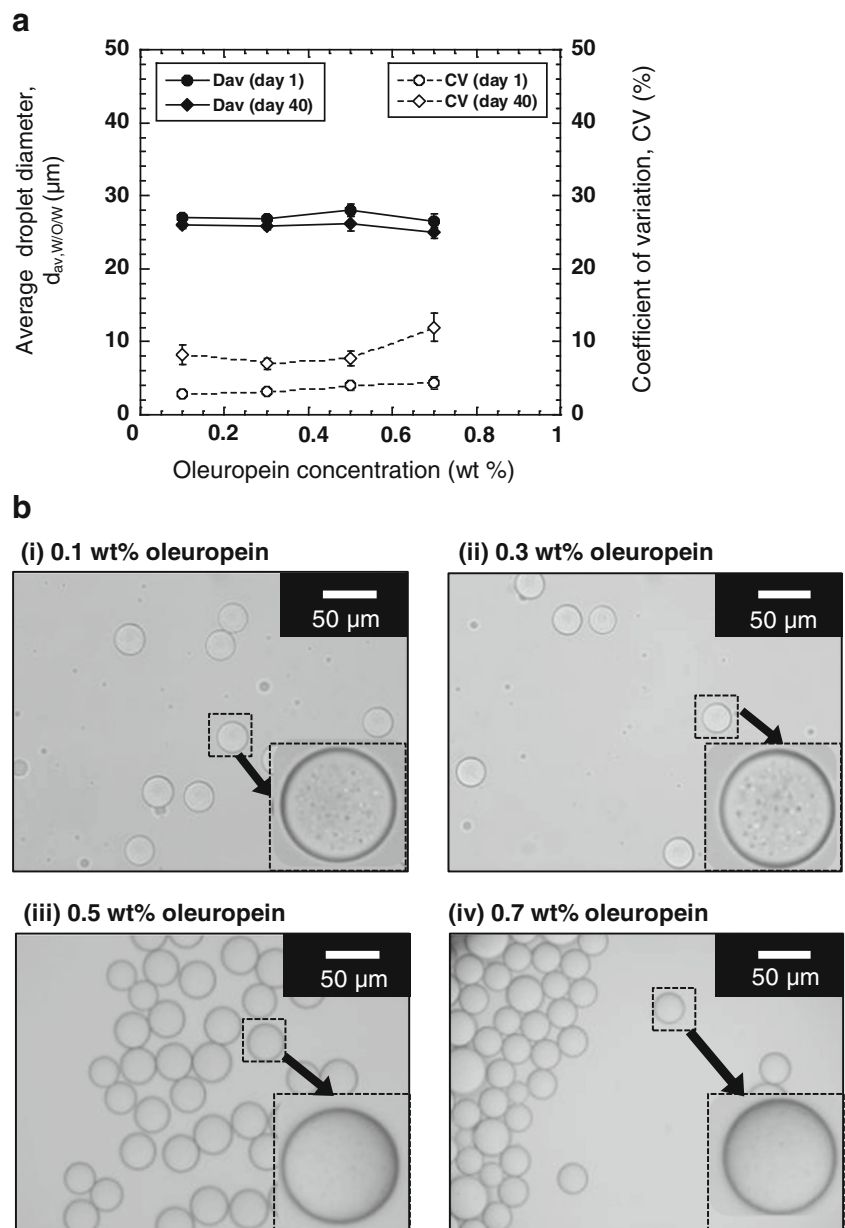

unstable internal water droplets that may be easily carried through the oil layer of W/O/W emulsions.

Effect of Oleuropein Concentration in the Internal Aqueous Phase

Figure 9a shows the variation in $d_{av, W/O/W}$ of the W/O/W emulsions during storage at different concentrations of oleuropein tested. The TCGR concentration in the oil phase was 5 wt.%. The $d_{av, W/O/W}$ of the resultant W/O droplets slightly decreased during storage, irrespective of the oleuropein concentration. Their CV values after 40 days were below 8 % at the oleuropein concentrations of 0.1 to 0.5 wt.% but reached 12 % at the oleuropein concentration of 0.7 wt.%. Figure 9b depicts photomicrographs of W/O/W emulsions after 40 days of storage at the preceding oleuropein concentrations. At the oleuropein concentrations of 0.1–0.3 wt.%, numerous, fine internal aqueous droplets could be observed (Fig. 9b(i, ii)). On the contrary, W/O droplets formed at the oleuropein concentrations of 0.5–0.7 wt.% appeared to be transparent with the lower fraction of internal aqueous droplets because of their progressive release into the external aqueous phase (Fig. 9b(iii, iv)). Unstable internal aqueous droplets at the higher oleuropein concentrations may be attributed to their wider size distributions (Fig. 3b). The micrograph in Fig. 9b(iv) also confirmed coalescence of W/O droplets at the oleuropein concentration of 0.7 wt.%, causing an increase in CV value. All emulsion samples kept a whitish color during the entire storage period, indicating the small chemical degradation of oleuropein loaded to the prepared W/O/W emulsions.

W/O droplets containing 0.5–0.7 wt.% oleuropein in the internal aqueous droplets might be better stabilized by increasing the TGCR concentration. However, several researchers have suggested that the excess amount of hydrophobic emulsifier could greatly enhance the solubilization and mass transport of a hydrophilic compound through reverse micelle formation (Jager-Lezer et al. 1997; Mun et al. 2010). Model hydrophilic components with less surface activity have been previously encapsulated in W/O/W emulsions (Jager-Lezer et al. 1997; Lutz et al. 2009; Bonnet et al. 2009). As mentioned earlier, oleuropein with a high surface activity is assumed to affect the optimum hydrophobic emulsifier concentration in the oil phase used for preparing W/O/W emulsions.

Conclusions

The present study has demonstrated that monodisperse food-grade W/O/W emulsions loaded with oleuropein in submicron internal water droplets were successfully prepared by high-pressure homogenization and subsequent MC emulsification under appropriate device condition and hydrophobic

emulsifier and oleuropein concentrations. A key point for successfully preparing the internal submicron W/O emulsions is that hydrophobic TGCR molecules can sufficiently adsorb to the surface of newly formed internal aqueous droplets. To produce uniformly sized W/O droplets successfully, the channels must be wide enough to achieve the successful preparation of W/O/W emulsions without aggregation and coalescence of the internal aqueous droplets in front of the channel inlets. The entrapment yield of calcein in the prepared W/O/W emulsions indicates that a large portion of oleuropein was encapsulated in the internal aqueous droplets. During storage, the successfully prepared monodisperse W/O/W emulsions were stable against the variations in their $d_{av, W/O/W}$ and CV without visible release of the internal aqueous droplets. Our results are believed to provide information on how to produce successfully stable monodisperse W/O/W emulsions loaded with hydrophilic functional compounds with and without surface activity for food application using MC emulsification. The use of large MC emulsification devices (e.g., Kobayashi et al. 2010; 2012) could scale up the productivity of monodisperse W/O/W emulsions loaded with oleuropein.

Acknowledgments The authors are grateful to the Science and Technology Research Partnership for Sustainable Development (SATREPS) Project, financially supported by JICA and JST, Japan.

References

- Andreadou, I., Iliodromitis, E. K., Mikros, E., Constantinou, M., Agalias, A., Magiatis, P., et al. (2006). The olive constituent oleuropein exhibits anti-ischemic, antioxidative, and hypolipidemic effects in anesthetized rabbits. *The Journal of Nutrition*, 136(8), 2213–2219.
- Benavente-García, O., Castillo, J., Lorente, J., Ortuño, A., & Del Rio, J. A. (2000). Antioxidant activity of phenolics extracted from *Olea europaea* L. leaves. *Food Chemistry*, 68(4), 457–462.
- Benichou, A., Aserin, A., & Garti, N. (2004). Double emulsions stabilized with hybrids of natural polymers for entrapment and slow release of active matters. *Advances in Colloid and Interface Science*, 20(108–109), 29–41.
- Bonnet, M., Cansell, M., Berkaoui, A., Ropers, M. H., Anton, M., & Leal-Calderon, F. (2009). Release rate profiles of magnesium from multiple W/O/W emulsions. *Food Hydrocolloids*, 23(1), 92–101.
- Charrouf, Z., & Guillaume, D. (2007). Phenols and polyphenols from *Argania spinosa*. *American Journal of Food Technology*, 2, 679–683.
- Chu, B. S., Ichikawa, S., Kanafusa, S., & Nakajima, M. (2007). Preparation and characterization of β -carotene nanodispersions prepared by solvent displacement technique. *Journal of Agriculture and Food Chemistry*, 55(16), 6754–6760.
- Chuah, A. M., Kuroiwa, T., Kobayashi, I., & Nakajima, M. (2009). Effect of chitosan on the stability and properties of modified lecithin stabilized oil-in-water monodisperse emulsion prepared by microchannel emulsification. *Food Hydrocolloid*, 23(3), 600–610.
- Dickinson, E. (2011). Double emulsions stabilized by food Biopolymers. *Food Biophysics*, 6(1), 1–11.
- Durlu-Ozkaya, F., & Ozkaya, M. T. (2011). Oleuropein using as an additive for feed and products used for humans. *Journal of Food Processing and Technology*, 2(3), 113.

- Han, J., Talorete, T., Yamada, P., & Isoda, H. (2009). Anti-proliferative and apoptotic effects of oleuropein and hydroxytyrosol on human breast cancer MCF-7 cells. *Cytotechnology*, 59, 45–53.
- Hemar, Y., Cheng, L. J., Oliver, C. M., Sanguansri, L., & Augustin, M. (2010). Encapsulation of resveratrol using water-in-oil-in-water double emulsions. *Food Biophysics*, 5(2), 120–127.
- Iancu, M. N., Chevalie, Y., Popa, M., & Hamaide, T. (2009). Internally gelled W/O and W/O/W double emulsions. *e-Polymers*, 1(no. 099), 1–13.
- Jager-Lezer, N., Terrisse, I., Bruneau, F., Tokgoz, S., Ferreira, L., Clause, D., et al. (1997). Influence of lipophilic surfactant on the release kinetics of water-soluble molecules entrapped in a W/O/W multiple emulsions. *Journal of Controlled Release*, 45(1), 1–13.
- Jemai, H., El Feki, A., & Sayadi, S. (2009). Antidiabetic and antioxidant effects of hydroxytyrosol and oleuropein from olive leaves in alloxan-diabetic rats. *Journal of Agricultural and Food Chemistry*, 57(19), 8798–8804.
- Kawakatsu, T., Tragardh, G., & Tragardh, C. (2001). Production of W/O/W emulsions and S/O/W pectin microcapsules by microchannel emulsification. *Colloids and Surfaces A: Physicochemical and Engineering Aspects*, 189(1–3), 257–264.
- Kumar, R., Kumar, M. S., & Mahdevan, N. (2012). Multiple emulsions: a review. *International Journal of Recent Advances in Pharmaceutical Research*, 2(1), 9–19.
- Kobayashi, I., Lou, X., Mukataka, S., & Nakajima, M. (2005). Preparation of monodisperse aqueous-in-oil-in-aqueous emulsions using microfluidization and straight through microchannel emulsification. *Journal of the American Oil Chemists' Society*, 82(1), 65–71.
- Kobayashi, I., Neves, M. A., Wada, Y., Uemura, K., & Nakajima, M. (2012). Large microchannel emulsification device for mass producing uniformly sized droplets on a liter per hour scale. *Journal of Green Processing and Synthesis*, 1, 353–362.
- Kobayashi, I., Wada, Y., Uemura, K., & Nakajima, M. (2010). Microchannel emulsification for mass production of uniform fine droplets: integration of microchannel arrays on a chip. *Microfluid Nanofluid*, 8, 255–262.
- Lutz, R., Aserin, A., Wicker, L., & Garti, N. (2009). Release of electrolytes from W/O/W double emulsions stabilized by a soluble complex of modified pectin and whey protein isolate. *Colloids and Surfaces. B. Biointerfaces*, 74(1), 178–185.
- Markopoulos, C., Vertzoni, M., Agalias, A., Magiatis, P., & Reppas, C. (2009). Stability of oleuropein in the human proximal gut. *Journal of Pharmacy and Pharmacology*, 61(2), 143–149.
- Mataumoto, S., & Kang, W. W. (1989). Formation and applications of multiple emulsions. *Journal of Dispersion Science and Technology*, 10(4–5), 455–482.
- McClements DJ. (2005) *Food emulsions principles, practices, and techniques* (second edition). Boca Raton, CRC Press. p. 609.
- Muscholik, G. (2007). Multiple emulsions for food use. *Current Opinion in Colloid & Interface Science*, 12(4–5), 213–220.
- Mun, S., Choi, Y., Rho, S. J., Kang, C. G., Park, C. H., & Kim, Y. R. (2010). Preparation and characterization of water/oil/water emulsions stabilized by polyglycerol polyricinoleate and whey protein isolate. *Journal of Food Science*, 75(2), 116–125.
- Nakashima, T., Shimizu, M., & Kukizaki, M. (2000). Particle control of emulsion by membrane emulsification and its applications. *Advanced Drug Delivery Reviews*, 45(1), 47–56.
- Okushima, S., Nisisako, T., Torii, T., & Higuchi, T. (2004). Controlled production of monodisperse double emulsions by two-step droplet breakup in microfluidic devices. *Langmuir*, 20(23), 9905–9908.
- Richard, K., Apenten, O., & Zhu, Q. H. (1996). Interfacial parameters for spans and tweens in relation to aqueous-in-oil-in-aqueous multiple emulsion stability. *Food Hydrocolloids*, 10(2), 245–250.
- Rodis, P. S., Karathanos, V. T., & Mantzavinou, A. (2002). Partitioning of olive oil antioxidants between oil and water phases. *Journal of Agriculture and Food Chemistry*, 50(3), 596–601.
- Sajja, A., Trombetta, D., Tomaino, A., Cascio, R. L., Princi, P., Uccella, N., et al. (1998). 'In vitro' evaluation of the antioxidant activity and biomembrane interaction of the plant phenols oleuropein and hydroxytyrosol. *International Journal of Pharmaceutics*, 166(2), 123–133.
- Scherze, I., Knöfel, R., & Muschiolik, G. (2005). Automated image analysis as a control tool for multiple emulsions. *Food Hydrocolloids*, 19(3), 617–624.
- Su, J., Flanagan, J., & Singh, H. (2008). Improving encapsulation efficiency and stability of water-in-oil-in-water emulsions using a modified gum arabic (Acacia (sen) SUPER GUM™). *Food Hydrocolloids*, 22(1), 112–120.
- Sugiura, S., Nakajima, M., Ushijima, H., Yamamoto, K., & Seki, M. (2001). Preparation characteristics of monodispersed water-in-oil emulsions using microchannel emulsification. *Journal of Chemical Engineering of Japan*, 34(6), 757–765.
- Sugiura, S., Nakajima, M., & Seki, M. (2002). Effect of channel structure on microchannel emulsification. *Langmuir*, 18(15), 5708–5712.
- Sugiura, S., Nakajima, M., Yamamoto, K., Iwamoto, S., Oda, T., Satake, M., et al. (2004). Preparation characteristics of water-in-oil-in-water multiple emulsions using microchannel emulsification. *Journal of Colloid and Interface Science*, 270(1), 221–228.
- Van der Graaf, S., Schroën, C. G. P. H., & Boom, R. M. (2005). Preparation of double emulsions by membrane emulsification—a review. *Journal of Membrane Science*, 251(1–2), 7–15.
- Villa, C. H., Lawson, L. B., Li, Y., & Papadopoulos, K. D. (2003). Internal coalescence as a mechanism of instability in water-in-oil-in-water double-emulsion globules. *Langmuir*, 19(2), 244–249.
- Vladislavljević, G. T., & Williams, R. A. (2007). Multiple emulsions: technology and applications chapter 6. Recent developments in manufacturing particulate products from Double-emulsion templates using membrane and microfluidic devices. In A. Aserin (Ed.), *Multiple emulsions. Technology and applications* (pp. 121–164). New York: Wiley.
- Vladislavljević, G. T., Shimizu, M., & Nakashima, T. (2006). Production of multiple emulsions for drug delivery systems by repeated SPG membrane homogenization: Influence of mean pore size, interfacial tension and continuous phase viscosity. *Journal of Membrane Science*, 284(1–2), 373–383.
- Wang, Z., Neves, M. A., Yin, L.-J., Kobayashi, I., Uemura, K., & Nakajima, M. (2012). In vitro gastrointestinal digestibility of soybean oil–water emulsion droplets stabilized by polyglycerol esters of fatty acid. *Food Science and Technology Research*, 18(2), 149–156.